



**/ Danny 40x40 / 80x40**

**Budget-friendly Danny stores bicycles safely**

# / GENERAL

Danny is a durable bicycle bracket with an extra crossbar, which makes it easier to secure women's and children's bicycles. It is not only sleek and trendy, but also vandalism resistant due to the sturdy material from which it is made. Two bicycles can be stored on one module at a time.

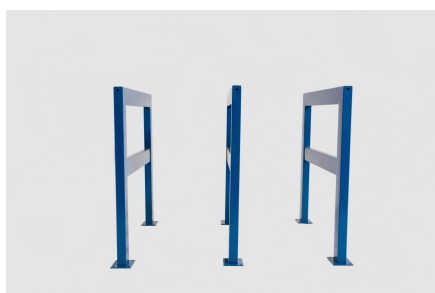

# / DATASHEET

## Structure

- Square / rectangular tube (HxWxd = 40x40x2mm or 80x40x2mm)
- 2 base plates (LxWxH = 110x110x5mm)
- Extension for concreting

## Material

- Steel

## Versions

- D = 40x40mm
- D = 80x40mm
- On base plates
- Concreting

## Connecting options

- Yes

## Dimensions

### Base plate

- LxDxH = 1000x40x800mm

### Concreting

- LxDxH = 1000x40x1100mm

## Surface treatment

- Hot-dip galvanized steel
- Hot-dip galvanized and powder coated steel

## Anchoring

- Concreting
- Base plates
  - Directly on the pavement by means of wedge bolts
  - With screws and plugs on 2 concrete blocks 30x30x40cm
  - By chemical anchoring

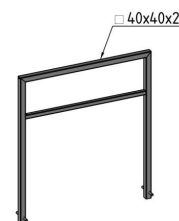
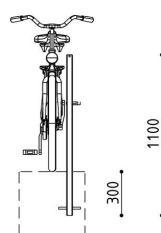
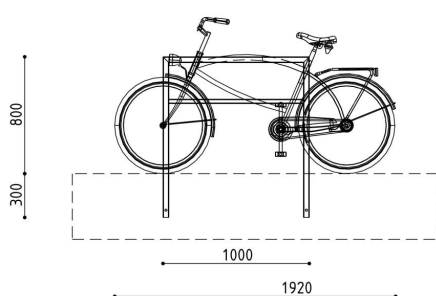
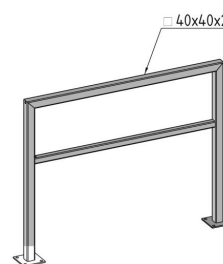
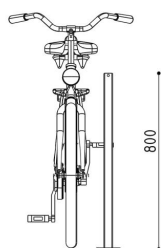
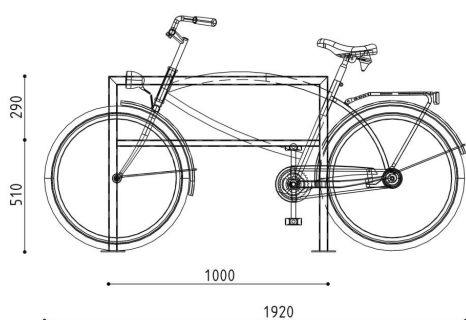

# / INSPIRE



